

T
TECHNO

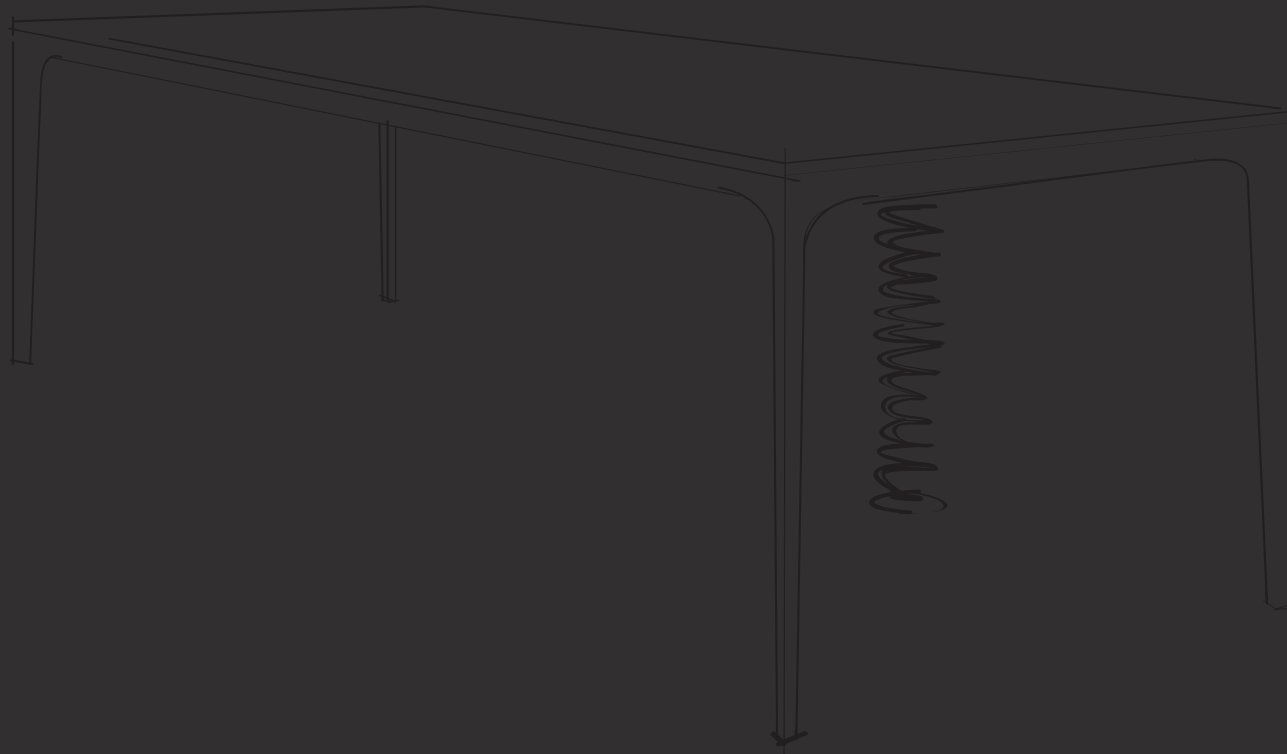

COLLEZIONE

 **NEWFORM**
UFFICIO

Collezione

NEWFORM UFFICIO representa el concepto del Made In Italy donde diseño y calidad se fusionan en un producto que supera todas las expectativas. La presencia en 120 países consolida el prestigio internacional de la marca.

Techno en calidad de importador exclusivo en el país, ha seleccionado las mejores opciones para el mercado brindando al distribuidor la facilidad de contar con un producto único con el cual poder enfrentar cualquier reto, desde áreas operativas a privados de lujo pasando por recepciones de alta calidad e impacto visual.

Haz de Techno tu partner para los negocios.

Índice

05 RECEPTION MIRÓ

11 OPERA

17 MIRÓ

25 TOWER EVO

35 KAMOS PLUS

41 KAMOS PURE

ÍNDICE

Es el concepto de belleza en su esencia.

Los diferentes materiales perfectamente combinados y las fusiones cromáticas, dan como resultado un mueble que cumple con los conceptos de ser acogedor, de ser nuestra tarjeta de presentación y de dar la bienvenida a la visita.

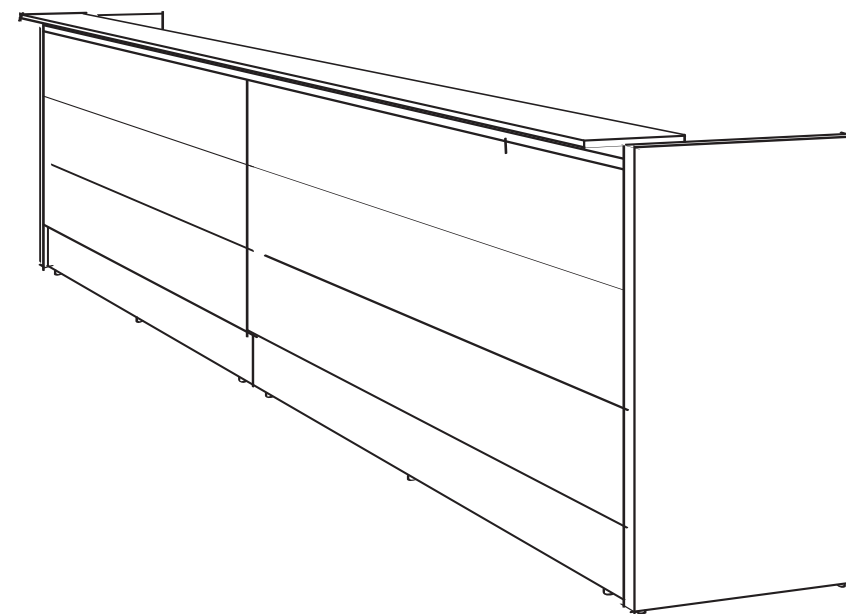

Reception Miró

RECEPTION MIRÓ

6

RE : ROJO ALTO BRILLO

RECEPTION MIRÓ



7

BL : NEGRO ALTO BRILLO

RECEPTION MIRÓ







Opera es la máxima expresión artística, sea ella musical, teatral o de arte. Cuando se habla de opera se representa un concepto refinado por naturaleza. Así, con esta ambición nació la línea Opera destinada a entendedores con gustos refinados.

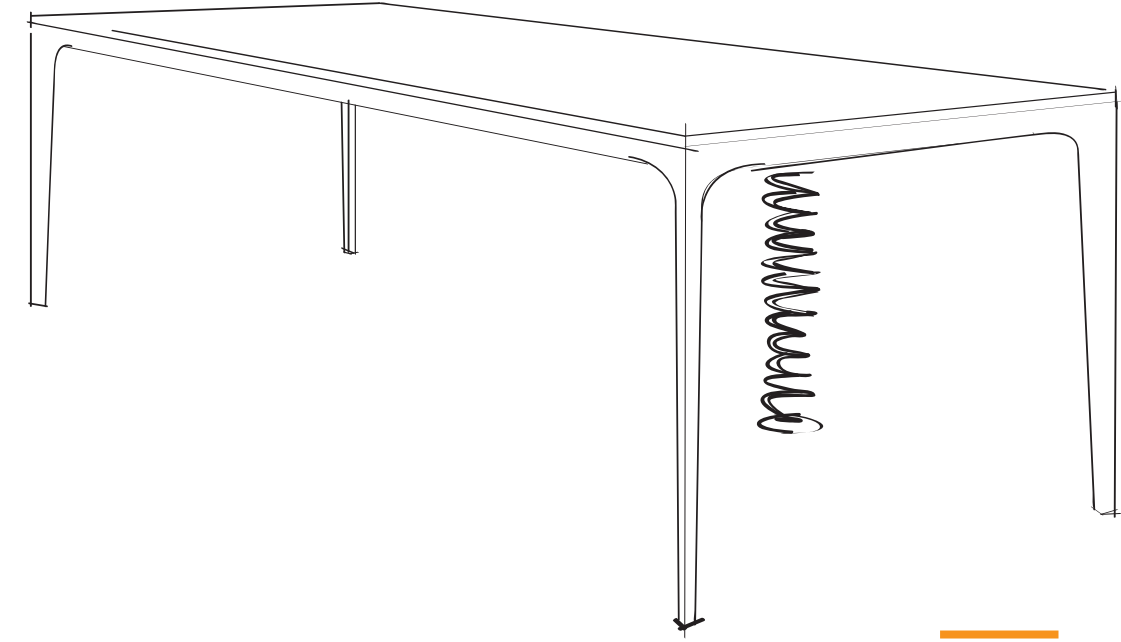

Opera

OPERA







Es la respuesta al deseo de tener algo único, diferente, original. Los materiales y combinaciones cromáticas que ofrece, hacen de Miró un mueble de tendencia que enfatizan el artista encerrado en cada uno de nosotros.



Miró

MIRÓ







56

56



De una forma arquitectónica sencilla como el trilito, nace Tower Evo, un mueble refinado y con combinaciones cromáticas que lo hacen agradable a la vista. Ideal para espacios destinados a la dirección o gerencia.

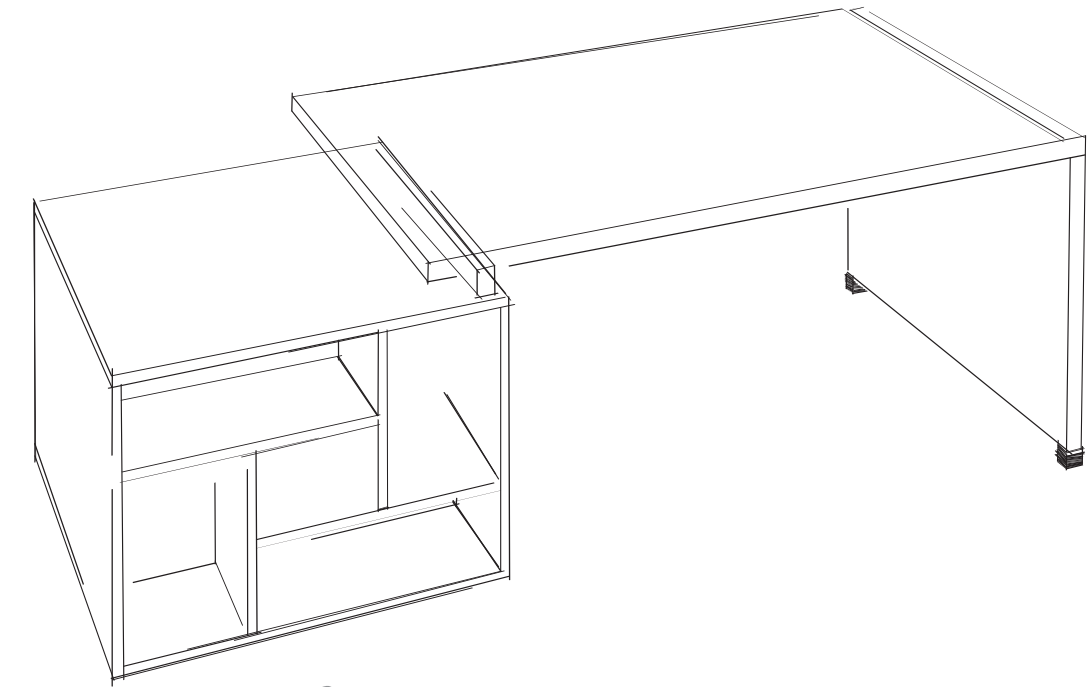

Tower Evo

TOWER EVO











Es la respuesta a la necesidad de muebles económicos pero funcionales y con buen contenido estético. Múltiples soluciones que se adaptan a todo tipo de espacio, amigable hasta en su sistema de armado. Kamos es la solución perfecta para proyectos con presupuesto limitado o con necesidad de entrega rápida.

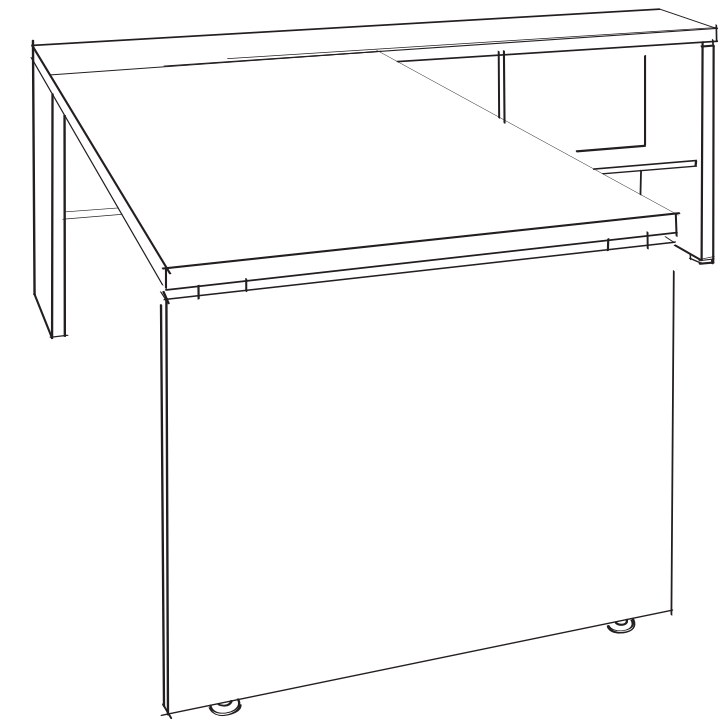

Kamos Plus

KAMOS PLUS





OT



OT



OT

Es la respuesta a la necesidad de muebles económicos pero funcionales y con buen contenido estético. Múltiples soluciones que se adaptan a todo tipo de espacio, amigable hasta en su sistema de armado. Kamos es la solución perfecta para proyectos con presupuesto limitado o con necesidad de entrega rápida.

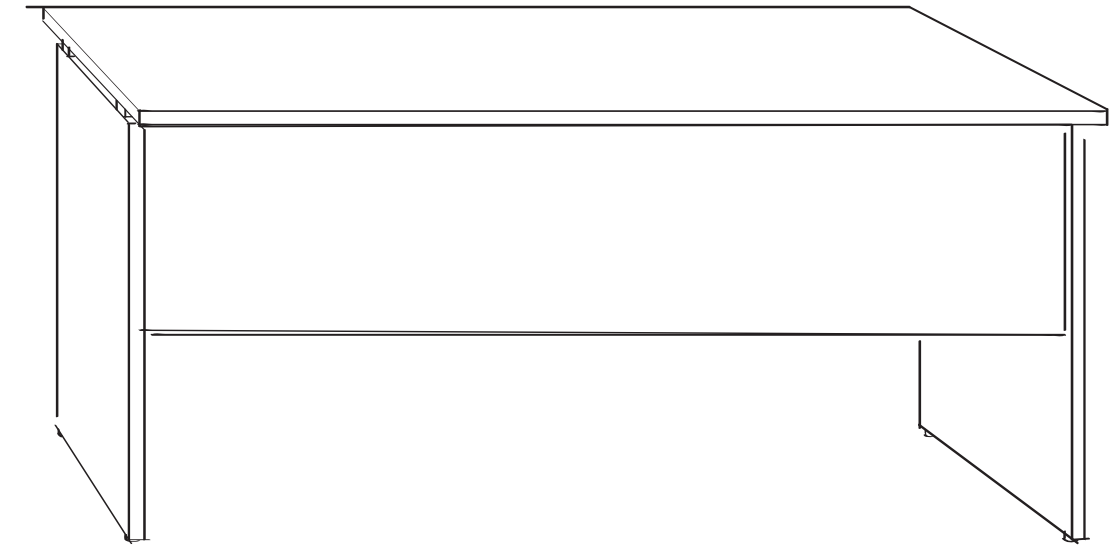

Kamos Pure

KAMOS PURE





GR



OT





OT



OT



VIDRIOS



METALES

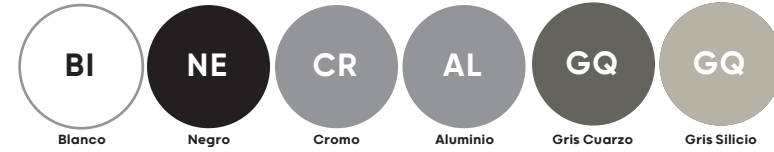

LAMINADOS



MELAMINAS

RECEPTION MIRÓ	Cubierta mostrador										Vistas	Vistas					Cuerpo y Cajonera						Vistas	Vistas
KAMOS PURE							Soporte cajonera										Gabinetes					Escritorios, Mesas, Cajoneras, Puertas, Costados y Top	Escritorios, Mesas, Cajoneras, Puertas, Costados y Top	Escritorios, Mesas, Cajoneras, Puertas, Costados y Top
KAMOS PLUS							Patas metálicas										Gabinetes						Escritorios, Mesas, Cajoneras, Puertas, Costados y Top	Escritorios, Mesas, Cajoneras, Puertas, Costados y Top
TOWER EVO		Cubierta escritorio						Pata	Pata								Gabinetes	Cubiertas, Cajoneras, Credenzas, Puertas, Costados y Top	Cubiertas, Cajoneras, Credenzas, Puertas, Costados y Top	Bases de Mesas de Juntas y Gabinetes Abiertos		Bases de Mesas de Juntas y Gabinetes Abiertos		
OPERA							Estructura escritorio		Estructura escritorio								Gabinetes	Cubiertas, Cajoneras y Libreros	Cubiertas, Cajoneras y Libreros	Boiserie		Boiserie		
MIRÓ							Patas cónicas e inclinadas	Patas cónicas	Patas cónicas				Cubiertas, Top y Puertas	Cubiertas, Top y Puertas	Cubiertas, Top y Puertas		Cajoneras, Credenzas, Top y Puertas							

RECEPTION MIRÓ

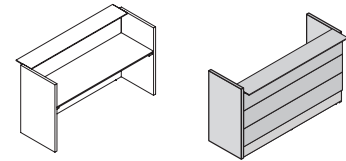

L	1.68 / 2.08
F	0.64
A	1.10

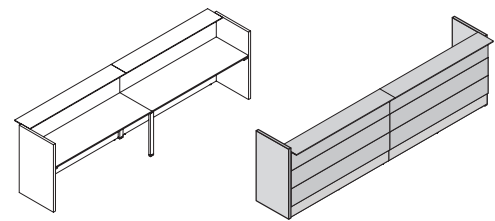

L	3.28 / 4.08
F	0.64
A	1.10

L	=	LARGO
F	=	FONDO
A	=	ALTURA

TOWER EVO

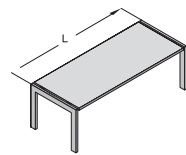

L	1.80
F	0.90

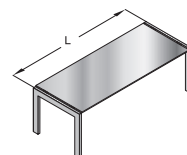

L	1.80
F	0.90

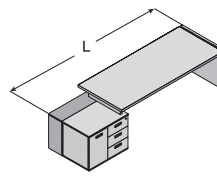

L	2.15
F	0.90

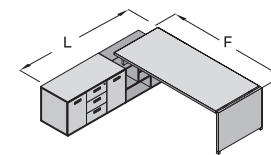

L	2.01
F	2.10

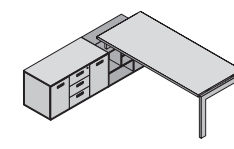

L	2.01
F	2.10

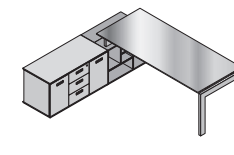

L	2.01
F	2.10



L	0.42
F	0.56
A	0.60

L	=	LARGO
F	=	FONDO
A	=	ALTURA

OPERA

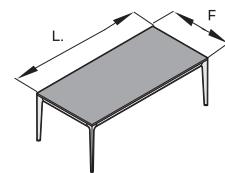

L	2.10
F	1.00

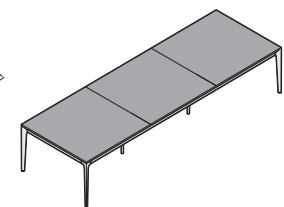

L	3.60 [3 x 1.20]
F	1.20



L	0.42
F	0.56
A	0.60

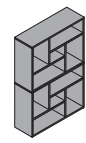

L	0.81
F	0.27
A	1.17

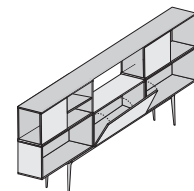

L	2.70
F	0.38
A	1.26

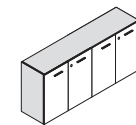

L	1.80
F	0.46
A	0.82

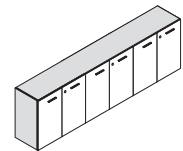

L	2.70
F	0.46
A	0.82

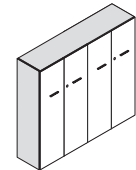

L	1.80
F	0.46
A	1.62

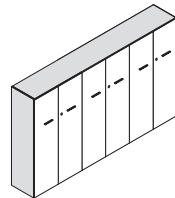

L	2.70
F	0.46
A	1.62

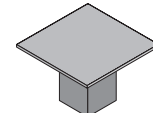

L	1.10
F	1.10

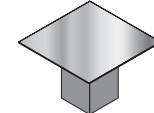

L	1.10
F	1.10

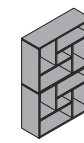

L	0.81
F	0.27
A	1.17

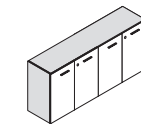

L	1.80
F	0.46
A	0.82

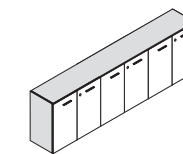

L	2.70
F	0.46
A	0.82

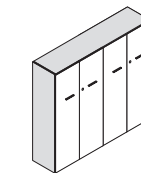

L	1.80
F	0.46
A	1.62

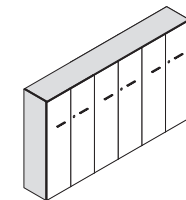

L	2.70
F	0.46
A	1.62

MIRÓ

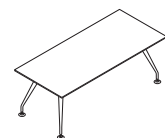

L	1.80 / 2.00
F	0.90

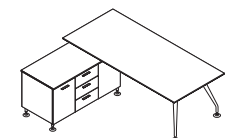

L	1.80 / 2.00
F	1.80

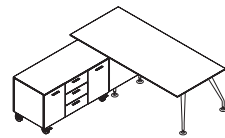

L	2.00
F	1.95

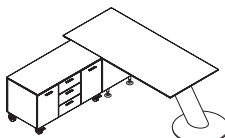

L	2.00
F	1.95



L	0.43
F	0.53
A	0.66

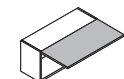

L	0.90
F	0.33
A	0.44

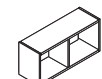

L	0.90
F	0.33
A	0.44

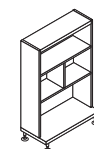

L	0.90
F	0.31 / 0.44
A	1.42

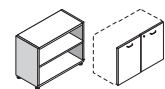

L	0.90
F	0.46
A	0.82

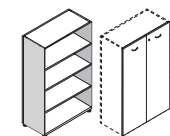

L	0.90
F	0.46
A	1.62

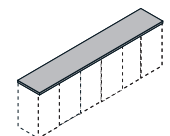

L	0.90 / 1.80
F	2.25 / 2.70

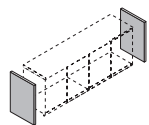

A	0.80
---	------

KAMOS PLUS

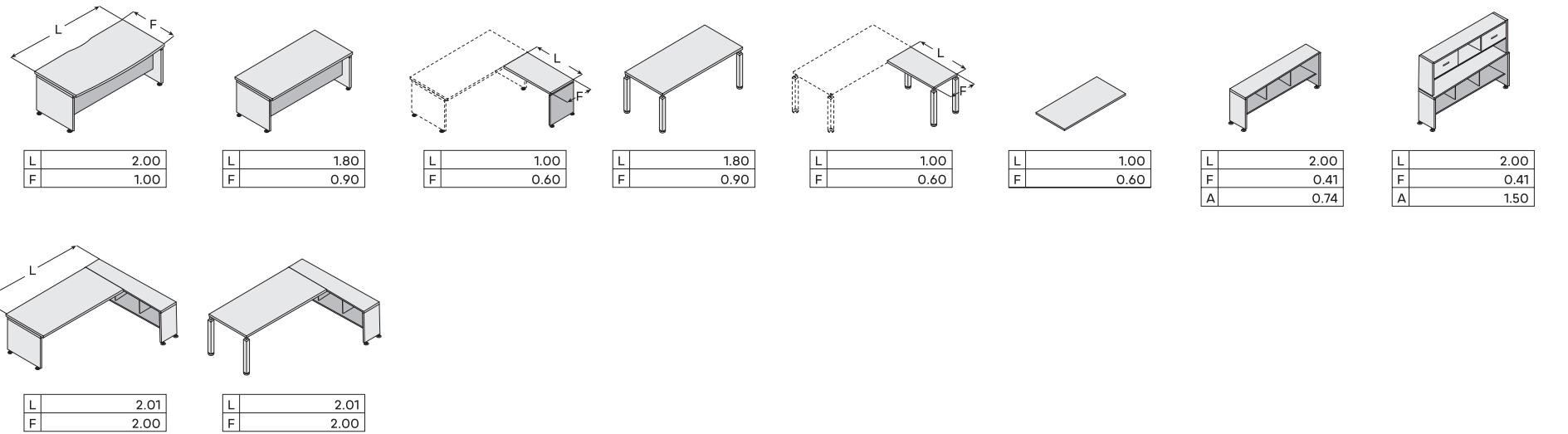

ELEMENTOS COMPARTIDOS KAMOS PLUS & PURE

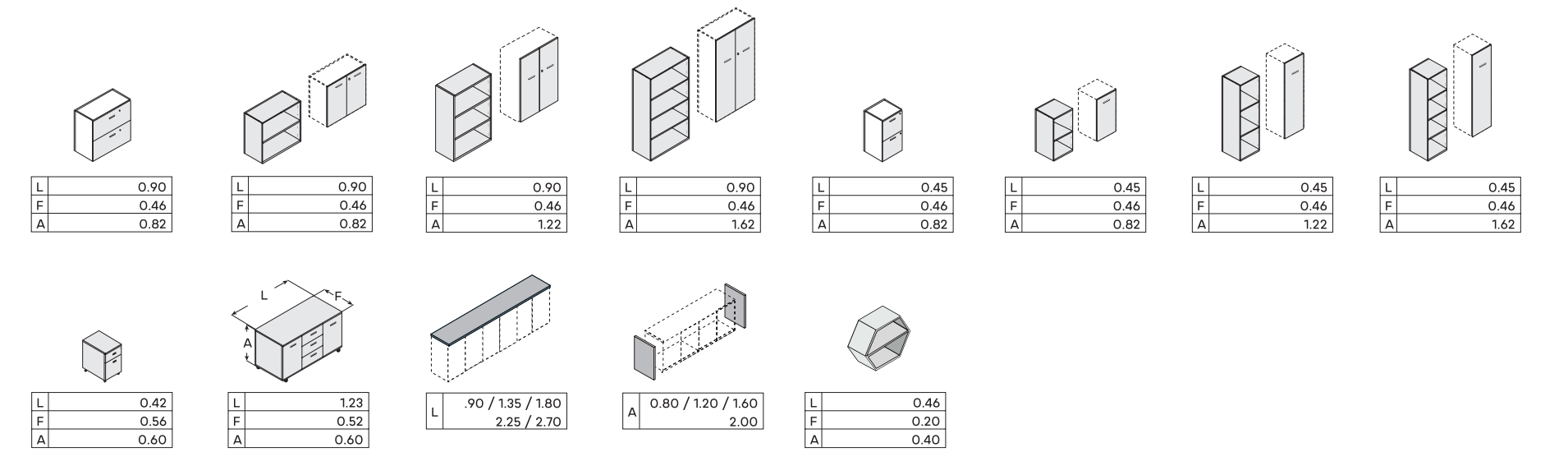

KAMOS PURE

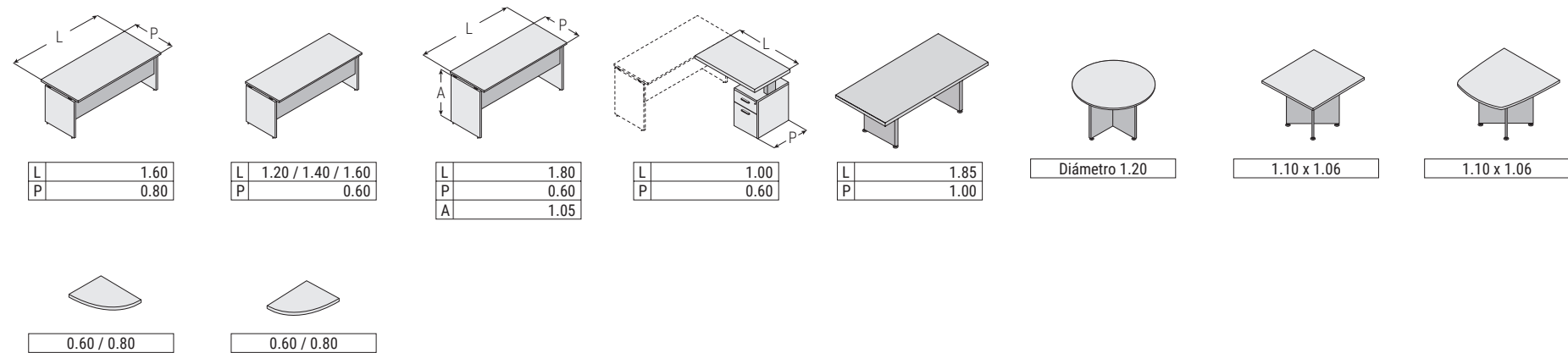

CERTIFICACIONES



